

Eureka!

FOR LIFE OUTDOORS.

Assembly Instructions for the Equinox 6:

This is a large tent and we recommend that you have help. With first time set-up or with windy conditions, you will need help.

Component List:

1 Tent Body	6 Poles	1 Fly	2 Brim Rods
1 Tent Bag	1 Pole Bag	1 Stake Bag w/ Stakes	

- Unpack the tent bag, pole bag and separate all of the components. Unroll and unfold the fabric with the Eureka! label up. Locate the hub fitting attached to the center of the roof. See fig.1.

Important: Align the hub arms to match the layout of the fabric.

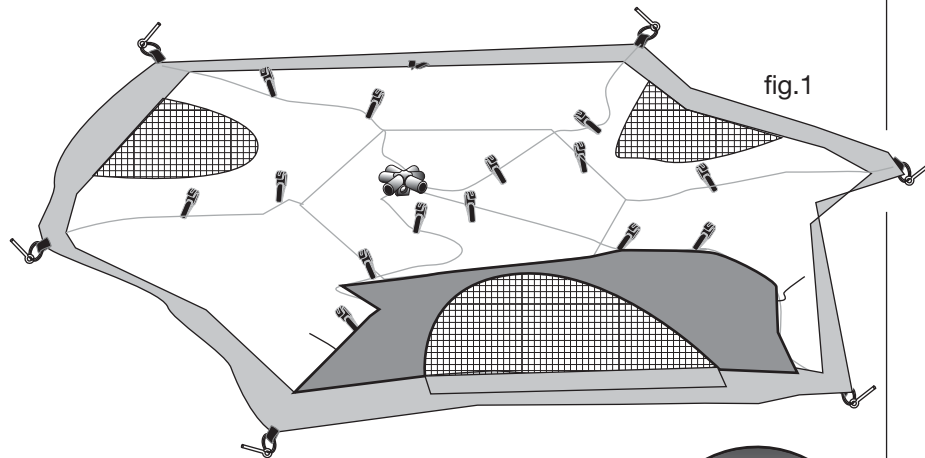

- Assemble all of the shockcordinated poles. Check and make sure that each section is fully seated into the next. Slide a swedged pole section labeled "TOP" into a hub arm. See fig.2.

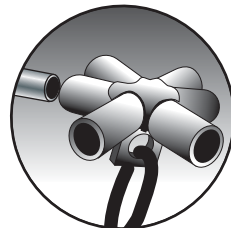

- Make sure the hub and fabric are still aligned. Then, insert the proper corner ring & pin into the bottom pole section. See fig.3.

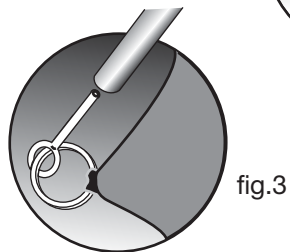

- Repeat with a second pole onto the opposite hub arm to form an arch. Attach the pole clips as you work. See fig. 4 & 5.

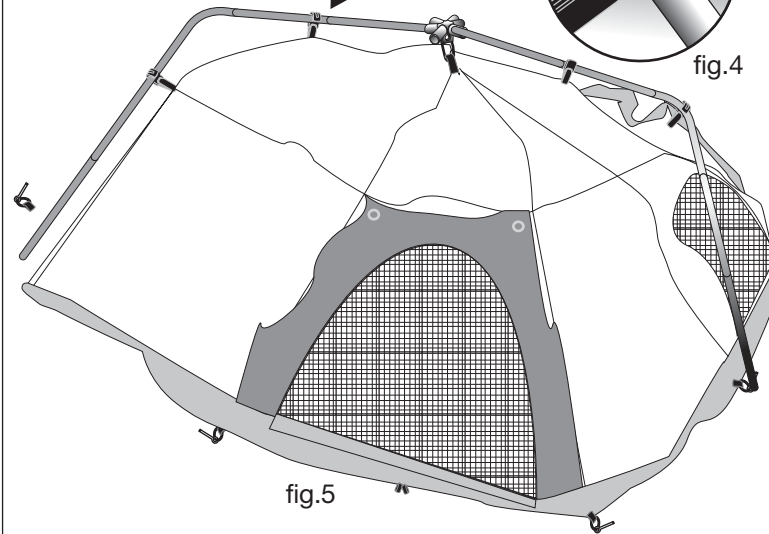
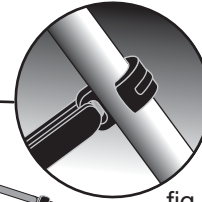

- Lift the arch and continue attaching all remaining poles and clips until you have a free standing structure. See fig.6.

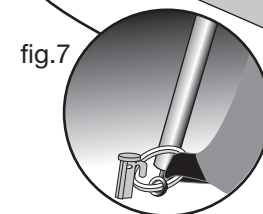
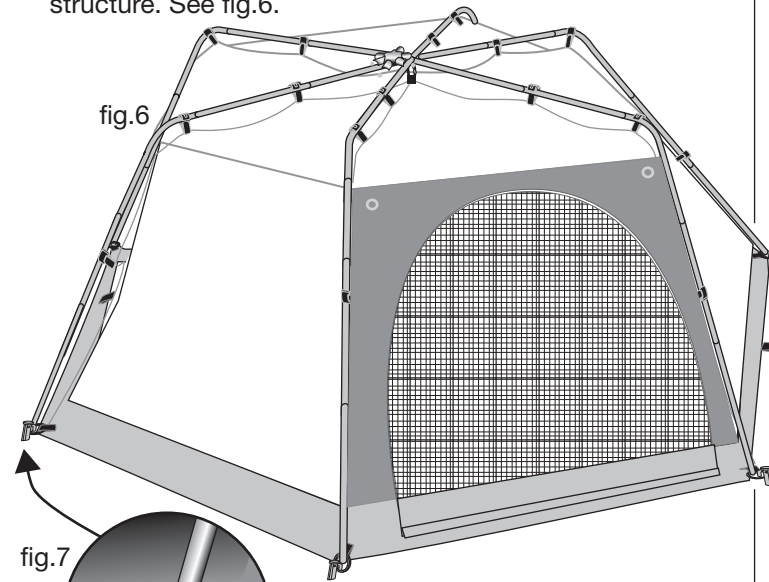

- Move the tent to the desired location and stake down all corner rings. See fig.7.

- Drape the fly over the tent with "Eureka!" above the door. Fit the brim rods into the grommets on the tent wall and into the web pockets on the underside of the fly. See fig.8.

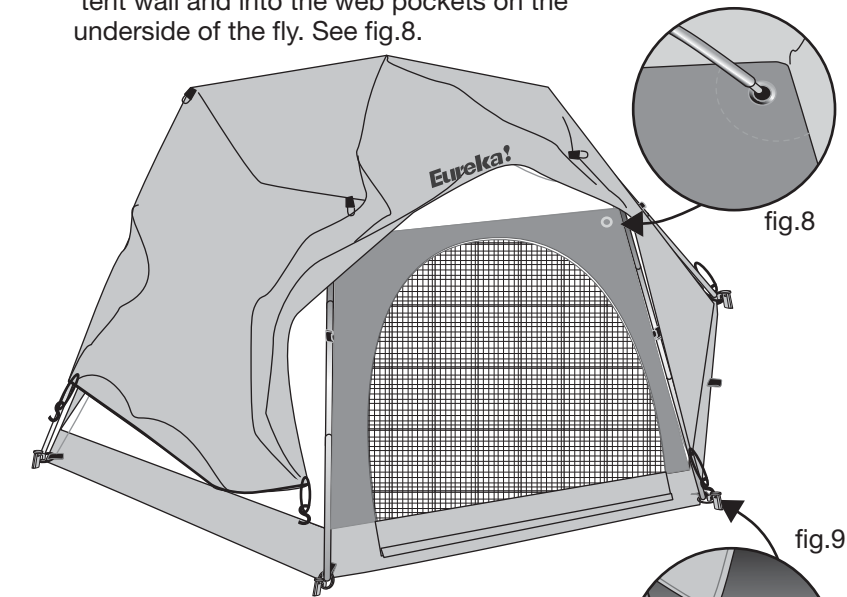

- Reach under the fly and locate the Velcro® tabs. Wrap these around the tent poles to secure the fly to the frame. Attach the shockcorded S-hooks from the fly to the staked rings. See fig.9.

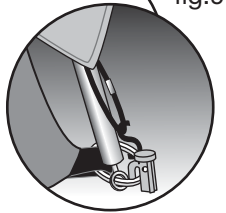

Your Tent is Ready for Use!

NOTE: In the event of strong wind, we recommend that the storm rings on the fly be guyed out. See fig.10.

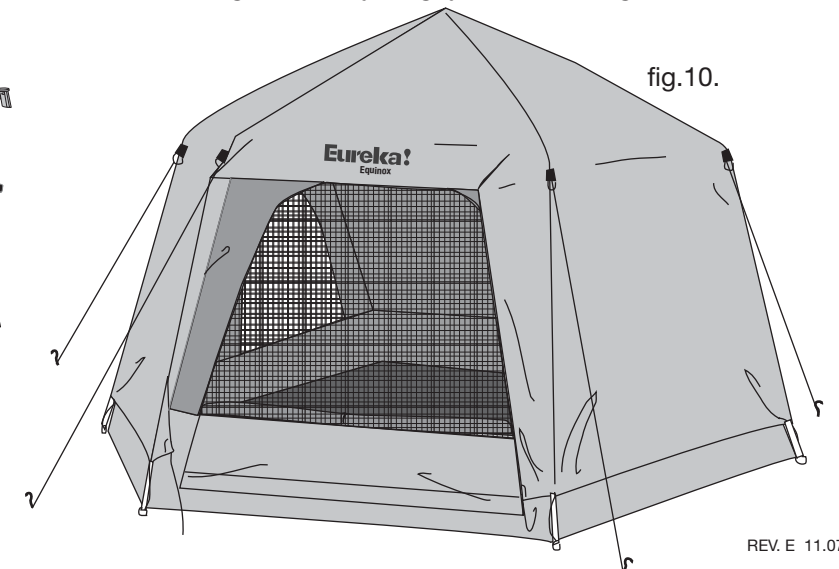

WARNING:

KEEP ALL FLAME AND HEAT SOURCES AWAY FROM THIS TENT FABRIC.

- This tent meets the flammability requirements of CPAI-84. The fabric may burn if left in continuous contact with any flame source. The application of any foreign substance to the tent fabric may render the flame-resistant properties ineffective.
- Do NOT operate any device which burns fuel inside your tent. Combustion consumes oxygen and can produce dangerous levels of carbon monoxide, which could lead to serious injury or death.

SEAM SEALING:

We recommend use of a sealer such as Kenyon Seam Sealer 3 or McNett Outdoor SeamGrip®.

- Work in a fully ventilated area.
- Set the tent up or lay the tent out flat. Taut seams allow for even application and penetration of the sealer.
- Decide which seams need to be sealed. For example, seams that will be exposed to rain, runoff, or ground level water are a must for sealing, while seams on uncoated nylon or mesh panels don't need treatment. There is no need to seal the seams in the roof or the factory taped seams. We recommend sealing both floor and fly seams and reinforcements.
- Apply sealant to the inside and outside of all exposed seams. Several thin layers will work better than one thick layer. Read and follow manufacture's instructions.

STAKING:

- All tents need to be staked down to keep them from blowing away. Securing the tent by placing heavy objects inside is just not adequate.
- Once the tent body is erected, stake it out before the fly is put on. This enables you to square the tent up to ensure that the fly goes on properly and that the seams align with the frame. Pull the base of the tent taut between each web stake out loop or ring & pin. Make sure that all corners are square. It is important that you don't stake the tent out too tightly. You will know it's too tight, if the door zippers can not be easily operated. Drive stakes through the web loops, or with ring & pin, drive the stake just outside the ring so that the "J" hook catches it. Tie a piece of cord or web into a loop through the ring to be used as a large stake loop if needed.
 - With the tent properly staked, drape the fly over the frame, attach its tent connection points and stake down any pull outs.
 - Do not attempt to remove the stakes by pulling on the tent becket loop, as this could cause the fabric to tear. The best way is to pry on the stake itself.

Staking in special conditions:

- **Sand.** Use long, broad stakes with plenty of surface area in loose soil.
- **Hard, Rocky, or Frozen Soil.** Steel stakes work best. Store steel stakes separately. Their sharp edges can cut fabric and leave rust stains, which might damage your tent.
- **Snow.** Use "dead man" anchors. Tie tent to buried objects (branches, tent bags, or stuff sacks filled with snow; or tie tents to snow shoes, skis, or ski poles, which are stuck in the snow.

GUY LINES:

- Do not depend upon staking alone to keep your tent secure during high winds. Most tent models have built-in loops or rings at optimal guy out locations. It's important to put in the extra time guying out your tent. Correctly done, it can save your tent during exceptional weather.
- Make sure that the top fly is securely attached to the tent frame. Ties, hook and loop, or dog-bones and elastic loops are sewn to the underside of the fly for this purpose.
 - Attach parachute cord to the loops/rings and stake them in the ground three or four feet from the edge of the tent. If staked too close to the tent, wind can cause an upward pull that could dislodge the stakes.

- If your tent does not have loops or rings for guy outs, attach guy lines 1/3 to 1/2 of the way up the framework on the main sidewalls. This enables the guy line to support the lower section of the pole, while the upper pole can flex and deflect wind gusts. It is best to run two cords at an angle from the side of the guy out. This prevents all movement, except toward the anchor. The guy lines will work together through opposition. See illustrations below:

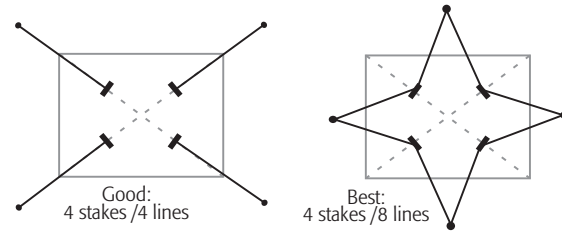

CONDENSATION & VENTING:

Through perspiration and breathing, an adult gives off about a pint of water overnight. If it cannot escape, the water vapor condenses to liquid. Most often, water found in the tent is a result of this condensation rather than from the tent leaking. Condensation often forms where the sleeping bag touches the side of the tent, under the sleeping pad, or on coated surfaces such as the door flaps. A tent's double wall construction allows the vapor to escape through the roof to the outside, keeping the inside of the tent dry.

Leave the windows partially open at night to provide cross ventilation and further reduce condensation. Cross ventilation becomes more important in very humid or extremely cold conditions when the permeable roof is less effective. The features that enhance ventilation are windows, short-sheeted flies (bottom venting), roof vents, and High/Low venting doors. These are specific to each tent model.

Given the importance of proper ventilation, We use High/Low venting in most of our tents. This allows cooler air in through the low vents and warmer, moist air up and out through the high vents. High/Low venting is accomplished within the inner tent via roof vents, doors and windows. It is important to vent the vestibule. Unvented, it can inhibit airflow into the tent. Our tent vestibules profit from the ability to "short sheet" by means of zippers & toggles and staked vestibule pull outs create a bellowing effect.

Most of our tents are equipped with a High/Low venting door. This design allows increased airflow into the tent from the bottom. Open the low vent/window to admit cool air, allowing the warmer air out through the high roof vents. When rain and wind prevent the low vent from being opened, the high door vent can still be used. Fly overhangs or vestibules protect it.

ULTRAVIOLET LIGHT:

Ultraviolet light damage to tent fabric is caused by excessive exposure to sunlight. While our fabrics are UV resistant, any synthetic fabric is susceptible to UV degradation. UV damage will cause nylon and polyester to become brittle and tear easily. We recommend that you use the rain fly even on clear days. It acts as a sunscreen to the tent. A rain fly is both easier and less expensive to replace if damaged. UV damage can be minimized by erecting tents on shaded sites with low exposure to direct sunlight.

GENERAL POLE CARE:

- Never let tent poles snap together as this can damage the pole end.
- Do not drop tent or pole bags on their ends and do not bounce a tent bag on its end to get the tent out. These actions may cut the shock cord and damage the pole ends.
- The aluminum frame may bend slightly and take a "set" through usage; this normally does not affect the performance of the frame.

GENERAL TENT CARE:

- Sweep the tent floor daily to prevent damage from stones.
- Try not to wear shoes inside your tent.
- Use a ground cloth whenever possible.
- Do not keep food inside a tent. Hungry critters will chew through tent fabric in search of food.

STORAGE:

- Make sure the tent is completely dry, then store loosely rolled, in a dry, cool place. To prevent dust from collecting on the tent, cover it with a cloth. This allows the nylon/polyester fabric to breathe.
- Ideally, the tent poles should be stored in their fully assembled state. This reduces the tension on the shock cord, prolonging its life.
- The tent bag should be used only as a carry sack and not for storage.

COLOR TRANSFER:

- Do to the nature of tent fabrics, color can transfer from darker to lighter fabrics when the two fabrics are in contact over time when wet, damp or exposed to the combination of moisture and high heat. This does not effect the tent's performance. To prevent / minimize color transfer, always make sure your tent is completely dry prior to packing and storage.

CLEANING:

- Clean the tent by setting it up and wiping it down with a mild soap (liquid hand soap) and lukewarm water solution. Rinse thoroughly and dry completely. Never use detergent, washing machines or dryers because they can damage the tent's protective coating and seams. After cleaning, be sure the tent is completely dry, especially the heavier, double-stitched areas such as the seams, before storing or mold / mildew are likely to grow.
- Clean the tent poles with a cloth and lubricate them with silicone spray. This is especially necessary after ocean side camping to remove salt spray so the poles don't corrode or stay gritty.
- Clean the zippers with a quick dip in water and then dry them off. This is especially important if you've been camping in a location with sand/dirt. If you don't clean the zippers, the sliders will wear out and eventually the teeth will become inoperable.

ALTERATIONS OR MODIFICATIONS:

DO NOT misuse, modify or alter this product in any way from its condition at the time of sale. Alteration, modification or any use of this product contrary to the accompanying written instructions shall void the warranty. Moreover, any misuse, alteration or modification of the product shall absolve Johnson Outdoors Gear LLC of any liability for property damages or injuries sustained as a result of such misuse, modification or alteration.

LIMITED WARRANTY:

What Is Covered: Johnson Outdoors Gear LLC warrants to the original purchaser that its products are free from defects in material and workmanship, for the life of the product, except as qualified below. The life of the product is determined from the date of purchase until such time as the product is no longer serviceable due to normal wear and tear.

What Is Not Covered: Johnson Outdoors Gear LLC shall not be responsible for the natural breakdown of materials that occurs inevitably with extended use (e.g., Ultra Violet (UV) light damage on tents, exhausted zippers), or defects caused by accident, abuse, alteration, animal attack, storm damage, misuse or improper care.

THERE ARE NO OTHER EXPRESS WARRANTIES BEYOND THE TERMS OF THIS LIMITED WARRANTY. IN NO EVENT SHALL JOHNSON OUTDOORS GEAR LLC BE LIABLE FOR INCIDENTAL OR CONSEQUENTIAL DAMAGES.

Some states do not allow the exclusion or limitation of incidental or consequential damages, so the above limitation or exclusion may not apply to you.

What Johnson Outdoors Gear LLC Will Do: If after inspection we find that a product failed due to a manufacturing or material defect, we will repair or replace the product, at our option, without charge.

How to Obtain Warranty Service: Return the product, freight prepaid, to the Dealer from whom it was purchased; or, contact our Customer Satisfaction Department for return authorization: toll free 1-800-572-8822. Collect shipments or shipments without return authorization cannot be accepted. The product registration card packaged with our product need not be returned for the warranty to be effective and for you to receive warranty service.

Repairs: If your Johnson Outdoors Gear LLC product needs service or repair due to normal wear and tear, animal attack, accident or some other reason that is not covered under the warranty we will provide the necessary service for a reasonable charge, plus shipping and handling. We require that products accepted for any repair be properly cleaned according to our recommended care instructions. Please send your product or component that requires repair (e.g., tent fly), postage prepaid, along with a description of what needs attention. For service and repairs, please contact our Customer Satisfaction Department: toll free 1-800-572-8822

How State Law Relates To This Warranty: This warranty gives you specific legal rights, and you may have other rights that vary from state to state.

JOHNSON
OUTDOORS

JOHNSON OUTDOORS GEAR LLC

Our experience building quality outdoor equipment goes back over 100 years! Today, we manufacture **sleeping bags, screen houses, day-use shelters and camping tents**. We also design and manufacture tents for the **United States Military** and for the **rental industry**. See eurekatents.com

From **baseplate and digital compasses to electronic instruments**, our sister brands, Silva and Tech4o, put outdoor technology at your fingertips. See tech4o.com and silvausa.com

Our brands are part of the Johnson Outdoors family of products. Visit all the brands at johnsonoutdoors.com

We support the "Leave No Trace" Seven Principles:

1. PLAN AHEAD AND PREPARE
2. TRAVEL & CAMP ON DURABLE SURFACES
3. DISPOSE OF WASTE PROPERLY
4. LEAVE WHAT YOU FIND
5. MINIMIZE CAMPFIRE IMPACTS
6. RESPECT WILDLIFE
7. BE COURTEOUS OF OTHER VISITORS

