

# Eureka! SPRK CAMP GRILL™

FOR OUTDOOR USE ONLY.

ANS Z21.72 · CSA 11.2-2019 Camp Stove



## Instruction Manual

- Read and comply with all instructions and warnings in this manual before using this Product. Keep these instructions for future reference.

### ⚠ DANGER



### CARBON MONOXIDE HAZARD

This appliance can produce carbon monoxide which has no odor. Using it in an enclosed space can kill you. Never use this appliance in an enclosed space such as a camper, tent, car or home.

### Model 2572202

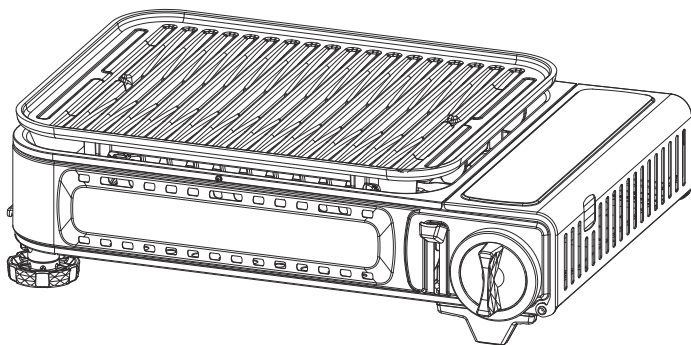

### ⚠ WARNING

If you smell gas:

- Do not attempt to light appliance.
- Extinguish any open flame.
- Disconnect from fuel supply.
- Evacuate immediately.
- Allow gas to dissipate 5 minutes before relighting the appliance.

Failure to follow these instructions could result in fire or explosion, which could cause property damage, personal injury, or death.

### FOR YOUR SAFETY

Do not store or use gasoline or other liquids with flammable vapor in the vicinity of this or any other appliance.

### DANGER

Failure to comply with the precautions and instructions provided with these grills can result in death, serious bodily injury and property loss or damage from hazards of fire, explosion, burn, asphyxiation, and / or carbon monoxide poisoning. Only persons who can understand and follow the instructions should use or service this grill.

If you need assistance or information such as an instruction manual or labels, contact your seller.

#### • EXPLOSION - FIRE HAZARD

- NEVER store butane near high heat, open flames, pilot lights, direct sunlight, other ignition sources or where temperatures exceed 120 degrees F (49°C).
- NEVER install or remove butane canister while outdoor grill is lighted, near flame, pilot lights, other ignition sources or while outdoor grill is hot to touch.
- During operation, this product can be a source of ignition. NEVER use the grill in spaces that contain or may contain volatile or airborne combustibles, or products such as gasoline, solvents, paint thinner, dust particles or unknown chemicals. Minimum clearances from combustible materials: 1m / 3ft.
- Provide adequate clearances around air openings into the combustion chamber.
- Butane canisters must be stored outdoors, in a well ventilated space, out of the reach of children, and must not be stored in a building, garage, or any other enclosed area.

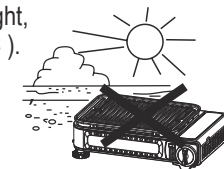

**WARNING:** Provide ample ventilation when using this appliance. This appliance consumes oxygen. To avoid endangering your life, do not use this appliance in unventilated structures. Provide additional ventilation for any additional burning products or additional occupants.

Do not connect to a remote gas supply.

Johnson Outdoors Gear, Inc.  
625 Conklin Road,  
Binghamton, NY 13903  
T: 1.800.847.1460

Johnson Outdoors Gear, Inc.  
4180 Harvester Rd,  
Burlington, ON L7L 0C1 Canada  
T: +1.905.634.0023



## NAME OF PARTS

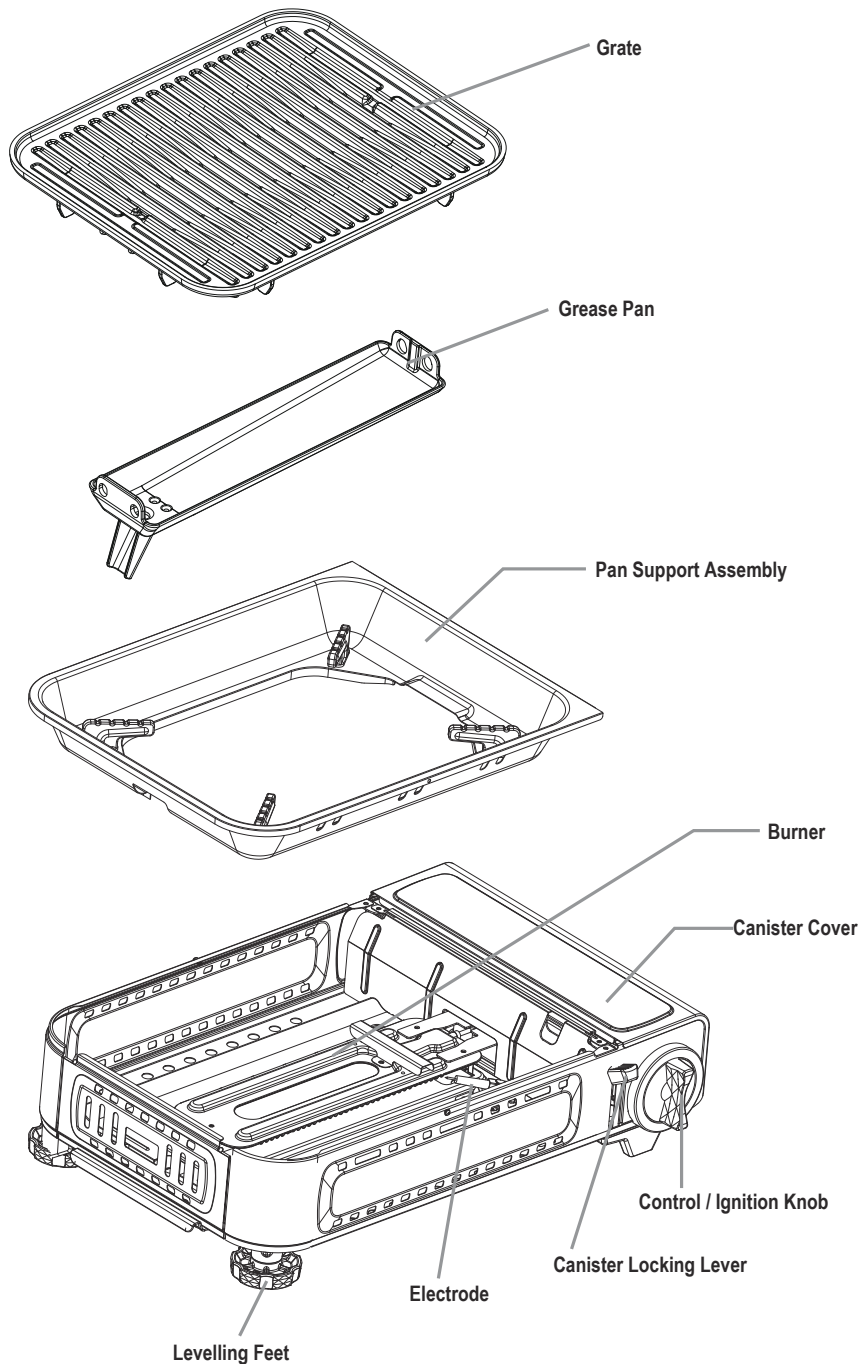

## PRECAUTIONS FOR FUEL USE

This appliance is only intended for use with butane canisters that are designed for vapor withdrawal only. This is done by lining up the notch in the collar of the canister with the safety guide on the regulator. They must fit together or the canister will not lock into place.

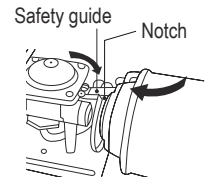

- The butane fuel canister shall comply with DOT 2P or 2Q requirements and shall be listed to the Standard for Non-refillable (Disposable) Type Metal Canister. Assemblies for Butane, UL 147B.



- Avoid any strong shock or impact to the fuel canister. Keep canisters upright for storage.
- Remove canister from grill before storing.
- Never move or tip stove while fuel canister is engaged. This may cause excessive fuel to be trapped in the unit after fuel canister removal.

- Do not dispose of empty gas canister into fire, risk of explosion may occur.
- Use only butane set up for vapor withdrawal.
- Performance may be suboptimal if used in extreme conditions (cold, hot, wind, altitude).



## MAINTENANCE AND CAUTIONS

- Never leave the grill unattended when hot or when in use.
- The Grate has a non-stick coating. Wipe clean with soft cloth and mild dish detergent to prolong life of nonstick coating. Do not use abrasives.
- Keep out of reach of children at all times.
- Keep the grill area clear and free of combustible materials, gasoline and other flammable vapors and liquids.
- Do not obstruct the flow of ventilation or combustion air around the appliance.
- Do not modify the appliance.
- Use a soft cloth to clean greasy parts of the grill with soap and water.
- Keep the electrode and the burner gap free from debris for easy lighting.
- Clean grill frequently to avoid grease build up and as necessary.
- Burner flame should be blue with hint of yellow tip.
- A good flame should be blue with minimal yellow tip. Some yellow tips on flames are acceptable as long as no carbon or soot deposits appear.

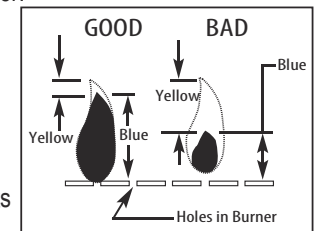

## BUTANE INFORMATION AND STORAGE

In a home or residence, the canister must be removed from the grill and the canister must be stored outdoors in a well ventilated area, out of the reach of children. They shall not be stored in a building, garage or any other enclosed area.

The grill may be stored indoors but only if the canister is removed.

When the grill is not in use or in storage, always remove the fuel canister.

## SAFETY PRECAUTIONS

- Do not carry the unit while it is burning. (Fig.1)
- Do not touch the unit while in use or just after use.
- Do not overheat the grill.
- Do not use two or more grills adjacent to each other. (Fig.2)
- Do not use as a heater.
- Never use the grill without the pan support.
- Never use aluminum foil to line Grease Pan or cover Grate.
- Avoid direct sunlight or other heat sources that could exceed 120F. (Fig.3)
- Do not use in windy conditions as the flame may be extinguished. Gas will continue to flow creating a hazardous condition.
- Never use the grill near flammable materials or combustible vapors.
- Do not use this grill below shelves or where there is a danger of falling objects.

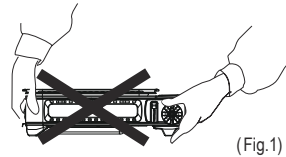

(Fig.1)

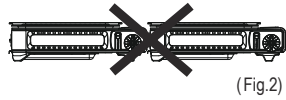

(Fig.2)

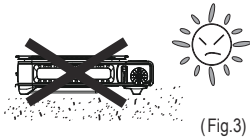

(Fig.3)

## TIPS BEFORE COOKING

**CAUTION:** Grate, Pan Support Assembly and Grease Pan must be in position prior to use.

NEVER use other cooking vessel.

## SETTING UP THE GRILL

**CAUTION:** Use only the gas pressure regulator supplied with this appliance. This regulator is set for an outlet pressure of 1.1psi.

**NOTE:** This portable gas grill shall be used with 227g (8 Oz.) non-refillable fuel gas canisters that are designed with a notch for vapor withdrawal only (refer to "PRECAUTIONS FOR FUEL USE" section in these Instructions).

If you can not locate a supplier in your area, please contact Eureka! at [www.eurekacamping.com](http://www.eurekacamping.com) for location information.

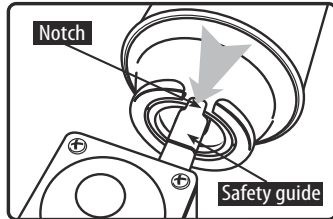

Contact your local dealer, distributor, or Eureka! for parts and / or service.

- Always place the grill on a horizontal, stable and heat resistant surface.
- Adjust levelling feet and check stability prior to use.
- Do not operate stove if levelling feet are missing or removed.
- Make sure Lever is in the "UNLOCK" position (otherwise canister cannot be installed). (Fig.4)
- Turn Control Knob clockwise to "OFF" position. (Fig.4)
- Open the canister compartment cover.
- To connect a gas canister, locate the notch on its collar, lift up the safety guide inside at the grill connection and insert canister so safety guide is inside canister collar notch.
- Push down the canister lever to "LOCK" position. (Fig.5)

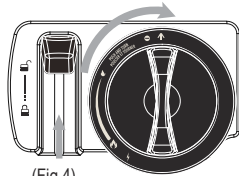

(Fig.4)

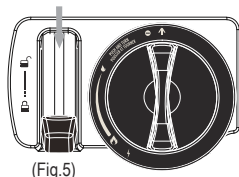

(Fig.5)

**CAUTION:** When replacing fuel canister, be sure no external sources of ignition are present.

**NOTE:** Check for leaks by using soapy water, Never use a flame. Bubbles indicate a leak.

**Failure to follow these procedures to properly install the canister and close the door can result in a gas leak.**

**NOTE:** Close the Canister Cover before lighting. Not closing the Cover properly may cause canister to overheat.

## LIGHTING THE GRILL

**The grill must not be exposed to flammable vapors or liquids during lighting.**

- Push and turn the Control Knob counter clock wise until you hear a click indicating that a spark has been produced. (Fig.6)
- If the grill does not light, turn the Control Knob back to "OFF" position and repeat previous step. (Fig.4)
- After three failed attempts, turn the gas supply off by turning the Control Knob clock wise to "OFF" position and return the Canister lever to "UNLOCK" position. (Fig.6)
- Open canister cover, remove canister and shake to verify that it is not empty.
- **CAUTION:** When canister needs to be replaced: if grill in use, do not touch the hot grill or any items that are on grill until they have cooled.
- If empty, replace canister following the "Setting up the grill" section.
- If canister is not empty, contact Customer Service.
- Adjust flame with Control Knob to desired heat. Reference "HIGH" and "LOW" flame indicators. (Fig. 7)

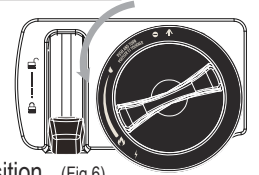

(Fig.6)

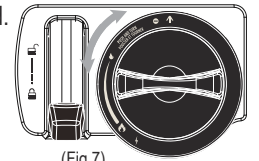

(Fig.7)

## Match Light:

- Turn Control knob clockwise to "OFF" position. (Fig.4)
- Push down the canister lever to "LOCK" position. (Fig.5)
- Hold lighted match next to Burner and turn Control Knob counter clockwise slowly.
- Adjust flame to desired heat lever. (Fig.7)

• Flame should be blue with hint of yellow tip.

• If burner does not light and Control / Ignition Knob is not completely in "OFF" position, gas is escaping and could cause an accident.

## TURNING OFF AND STORING THE GRILL

- Turn Control Knob clockwise to "AUTO-EJECT" position.
- Alternatively, turn Control Knob clockwise to "OFF" position and return lever to the "UNLOCK" position. (Fig. 8 & Fig. 9)
- Allow grill to cool for 10-15 minutes.
- Remove butane canister.
- Some gas remains in the unit after removing the canister. For your safety, do not attempt to use the valve until you have a canister installed and are prepared to use the stove.
- Store butane canister consistent with instructions and warnings on the canister.
- Use a soft cloth and clean greasy parts of the grill with soap and water or a nonabrasive detergent.
- Check Lever on grill to be sure it is in the "UNLOCK" position.
- Fuel canister must be disconnected when the grill is in storage.
- Store grill in a cool, dry and well-ventilated area, out of the reach of children.

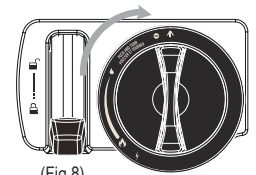

(Fig.8)

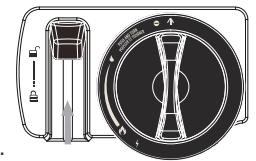

(Fig.9)

## HANDLING SAFETY DEVICE

The appliance is equipped with a safety device which stops the flow of gas if the pressure in the canister, e.g. because of overheating, becomes too high.

### To continue usage...

- Turn the control knob to "●" position.
- Return the canister lever to "☞" position and take the canister out.
- Follow the procedure for "SETTING UP THE GRILL" with a cooled canister.

## TROUBLE SHOOTING

Problem	Possible Solutions
No Gas Comes Out	Check if the gas canister was inserted and locked in properly. Check if the gas canister is empty. Check if the temperature is above 32F.
No Ignition	Check the igniter tip to see if it has been bent too far away from the burner for a spark to be produced.
Can not lock in The fuel canister	Check that the Control Knob is in the OFF position. Make sure the notch on the canister is lined up with the safety guide.
You smell gas	Check with soapy water for any gas leaks where the canister and regulator meet. If there is a leak and you have inserted the canister properly, contact customer service. Do not use.

**CAUTION: Butane is heavier than air and will seek the lowest point in a room. Ventilate the room and do not turn on any source of ignition, such as lights or appliance until room has been well ventilated. If gas odor is strong, evacuate the building and seek professional assistance.**

## SPECIFICATIONS

DEEP GRILL PAN PORTABLE GAS GRILL			
Model Number	2572202	Fuel canister/Nt. Wt	227 Grams (8 Oz.) DOT-2P/2Q (RVR)
Type of Ignition	Piezo-Electric	Type of gas	Butane
Dimension	16.6" x 11.5" x 4.6"	Fuel consumption	160 g/h
Weight	8.6 lbs (3.9 kg)	Input rating	7,250 Btu/Hr

## WARRANTY

This product is covered by a 1 year limited warranty.

Visit [www.eurekacamping.com](http://www.eurekacamping.com) for additional information.

For additional diagrams and FAQs, visit: [www.eurekacamping.com](http://www.eurekacamping.com)